

Buses taraudées

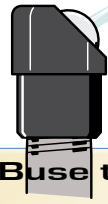
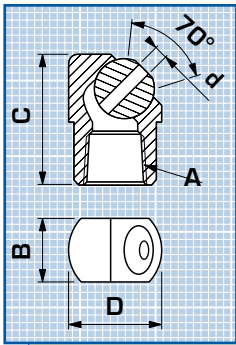

**Buse taraudée
Type CJ**

10 bar max

NPT - BSPT

Ø jet (mm)

A	(d)	B	C	D	Réf.
1/8"	2,8	12,7	20,8	16	CJ7510
1/8"	4	12,7	20,8	16	CJ7516
1/4"	2,8	16	23,9	19,05	CJ7524
1/4"	4	16	23,9	19,05	CJ7530
3/8"	2,8	19,05	28,7	22,35	CJ7560
3/8"	4	19,05	28,7	22,35	CJ7538
3/8"	5,6	19,05	28,7	22,35	CJ7544

Ø jet taraudé

A	(d)	B	C	D	Réf.
1/8"	M 5	12,7	20,8	16	CJ7523
1/4"	M 5	16	23,9	19,05	CJ7537
3/8"	M 6	19,05	28,7	22,35	CJ7552

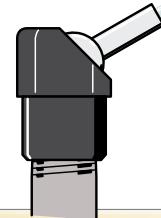
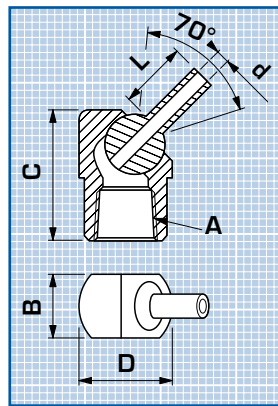

**Buse taraudée
Type CJ**

10 bar max

NPT - BSPT

Ø jet (mm)

A	(d) x L	B	C	D	Réf.
1/8"	2,8 x 6,35	12,7	20,8	16	CJ7512
1/8"	2,8 x 12,7	12,7	20,8	16	CJ7513
1/8"	2,8 x 31,7	12,7	20,8	16	CJ7514
1/8"	4 x 12,7	12,7	20,8	16	CJ7518
1/8"	3,8 x 31,7	12,7	20,8	16	CJ7520
1/4"	2,8 x 3,35	16	23,9	19,05	CJ7526
1/4"	2,8 x 12,7	16	23,9	19,05	CJ7527
1/4"	2,8 x 31,7	16	23,9	19,05	CJ7528
1/4"	4 x 12,7	16	23,9	19,05	CJ7532
1/4"	3,8 x 31,7	16	23,9	19,05	CJ7534
3/8"	4 x 12,7	19,05	28,7	22,35	CJ7540
3/8"	3,8 x 31,7	19,05	28,7	22,35	CJ7542
3/8"	5,6 x 12,7	19,05	28,7	22,35	CJ7546
3/8"	5,3 x 31,7	19,05	28,7	22,35	CJ7548

- Température d'utilisation :
70°C maxi

- Corps en acétal
- Buse en inox

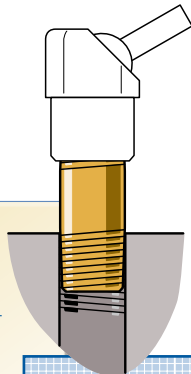

Raccord en laiton NPT / BSPT

A	B	L	Réf.
1/8"	1/8"	20 mm	DF8705
1/4"	1/4"	22 mm	DF8710
3/8"	3/8"	25 mm	DF8715
1/8"	1/8"	38 mm	DF8720
1/4"	1/4"	38 mm	DF8725
3/8"	3/8"	38 mm	DF8730

6 pans exter.

A	B	L	Réf.
M 12	1/8"	20,6 mm	DF8835
M14x1	1/8"	10,2 mm	DF8840
1/4"	1/8"	16,5 mm	DF8735
1/2"	1/4"	20 mm	DF9000
3/4"	1/4"	18,5 mm	DF8740

Cylindrique exter.

A	B	L	Réf.
1/8"	1/8"	20 mm	DF8745
1/4"	1/4"	24 mm	DF8750
3/8"	3/8"	26 mm	DF8755

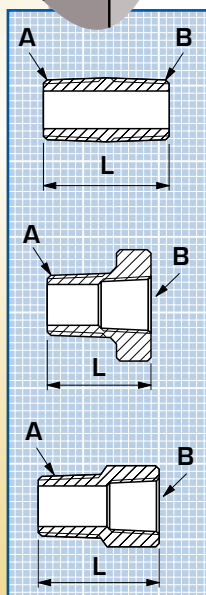

ARROSAJE HAUTE PRESSION

KOPAL 35

Adaptateurs taraudés

pour trous lisses

ARROSAJE HAUTE PRESSION

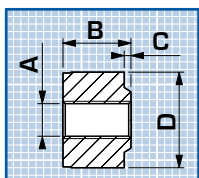

Adaptateur taraudé pour trou lisse

Type PP

Tolérance maxi du trou : H9

Ø trou D	taraudage A	B	C	Réf.
8 mm	M 6 x 1	6,0	0	PP4086
10 mm	M 6 x 1	6,0	0	PP4106
12 mm	M 6 x 1	6,0	0	PP4126
14 mm	M 6 x 1	7,1	1,1	PP4146
15 mm	M 6 x 1	7,1	1,1	PP4156
16 mm	M 6 x 1	7,1	1,1	PP4166
12 mm	1/8 NPT-BSPT	6,0	0	PP4121
14 mm	1/8 NPT-BSPT	6,0	0	PP4141
15 mm	1/8 NPT-BSPT	6,0	0	PP4151
16 mm	1/8 NPT-BSPT	6,0	0	PP4161

Outil de montage

pour adaptateurs M 6 IT1225
pour adaptateurs 1/8 IT1230



Extracteur

Kit d'extraction SH1306
pour tous types de raccord fileté :
M 3,5, M 4, M 5, M 6, 1/8 NPT-BSPT



● Plus de pression

● Plus de précision

● Remplacez les rotules d'origine par tous types de buses et tuyaux filetés, via l'adaptateur taraudé.

HP MAX 100 bars

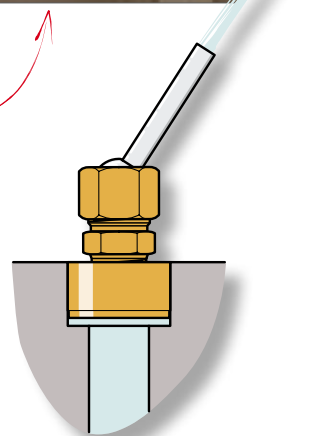

Raccord avec Buse LJ page 41

- Température d'utilisation : **150°C maxi**
- Adaptateur en laiton

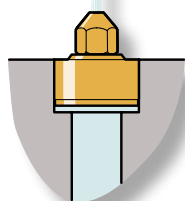

Raccord avec Gicleur ST page 37

1
Démontez la vis et la rotule

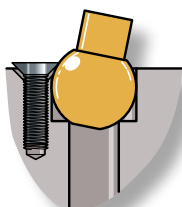

2
Insérez l'Adaptateur avec l'outil de montage et un maillet

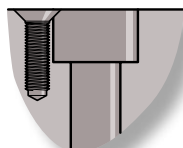

raccord avec Tube d'extension ET

3
Vissez l'extension de votre choix

